

# Terminal Blocks - Single Row

## Series A2000, LP2000 & CB2000 Single Row Terminal Blocks

### SPECIFICATIONS

Rating: A2: 30A, 300V\*

LP2: 30A, 150V\*

CB2: 30A, 300V\*

Center Spacing: 0.375" or 3/8" (9.52mm)

Wire Range: #12-22 AWG CU

Screw Size: #6-32 zinc-plated phillslot

Torque Rating: 9 lb-in.

Base: Standoffs standard for easy flux washing

Distance Between Barriers: 0.32" (8.1mm)

Recommended PCB Hole Diameter: 0.076" (1.93mm)

Operating Temperature: 105°C (221°F) max., -40°C (-40°F) min.

Molded Material: Black, UL Rated 94V0 Thermoplastic

Breakdown Voltage: 3400V (A2 & LP2); 4100V (CB2).

Agency Information: UL File E62622, CSA File 47235;

IEC Compliance; CE Certified

\*30A Rating achieved with a #10 copper wire crimped to a ring terminal.;  
20A Rating without ring terminal.



### Dimensions - in (mm)

#### A2000 & LP2000 Series



#### CB2000 Series



Poles	MOUNTING ENDS ONLY		BARRIER & MOUNTING ENDS B Pole Ctrs.	BARRIER ENDS ONLY C Length
	A Mount Ctrs.	C Length		
02	1.13	1.56	0.38	0.81
03	1.50	1.93	0.75	1.18
04	1.88	2.30	1.13	1.56
05	2.25	2.68	1.50	1.93
06	2.63	3.06	1.88	2.31
07	3.00	3.43	2.25	2.68
08	3.38	3.81	2.63	3.06
09	3.75	4.18	3.00	3.43
10	4.13	4.56	3.38	3.81
11	4.50	4.93	3.75	4.18
12	4.88	5.31	4.13	4.56
13	5.25	5.69	4.50	4.93
14	5.63	6.06	4.88	5.31
15	6.00	6.43	5.25	5.68
16	6.38	6.81	5.63	6.06
17	6.75	7.18	6.00	6.43
18	7.13	7.56	6.38	6.81
19	7.50	7.93	6.75	7.18
20	7.88	8.31	7.13	7.56
21	8.25	8.68	7.50	7.93
22	8.63	9.06	7.88	8.31
23	9.00	9.43	8.25	8.68
24	9.38	9.81	8.63	9.06
25	9.75	10.18	9.00	9.43
26	10.13	10.56	9.38	9.81
27	10.50	10.93	9.75	10.18
28	10.88	11.31	10.13	10.55
29	11.25	11.68	10.50	10.93
30	11.63	12.05	10.88	11.31
31	-	-	11.25	11.68
32	-	-	11.63	12.05

\* Dimensions in inches. To convert to millimeters, multiply by 25.4.

## Series A2000 & LP2000 Single Row Terminal Blocks

### Part Numbering System

Series	Terminal Style	Base/End	Poles	Screw Options	Options
<b>A</b> <b>2</b>					
<b>LP</b> <b>2</b>					
<b>A2</b> - standard barrier <b>LP2</b> - low profile barrier	<b>01</b> - handwired <b>02</b> - printed circuit <b>03</b> - non feed-thru <b>04</b> - wire wrap tail <b>05</b> - extended handwired <b>06</b> - handwired <b>07</b> - extended pin <b>08</b> - printed circuit <b>09</b> - 0.250" QC short <b>10</b> - 0.187" QC <b>14</b> - printed circuit <b>19</b> - 0.250" QC long	<b>0</b> - flat base/molded mount end <b>1</b> - flat base/mnt. end <b>2</b> - flat base/barrier end <b>3</b> - insulator base/mnt. end <b>4</b> - insulator base/barrier end <b>5</b> - closed base/mount end <b>6</b> - closed base/molded mount end <b>9</b> - insulator base/molded mount end  Base/End Note: 0, 6, 9 styles not available with covers. 5 & 6 Styles only available with 03 terminals.	<b>02 to 32</b> <b>02 to 30</b> on mount end base	Blank - std. screw <b>00</b> - screws shipped bulk <b>03</b> - stainless steel <b>04</b> - brass nickel-plated <b>07</b> - steel SEMS (not available with hardware options) <b>09</b> - brass SEMS nickel-plated (not available with hardware options) <b>CA</b> - captive screw <b>WR</b> - wire ready (not available on LP2 series)	<b>AB</b> - angle mnt. options (pg 9) <b>A1 to A9</b> - 0.250" QC <b>B1 to B9</b> - 0.187" QC <b>DR</b> - drilled right angle (pg 9) <b>†JA, JB &amp; JC</b> - barrier jumpers <b>L1 to L6</b> marking options (pg 22) <b>MP, MP8 &amp; MT</b> mounting plates (pg 9) <b>†OJ2 &amp; OJ4</b> - over barrier jumpers (not available w/covers) <b>RC</b> - retaining clips (pg 9) <b>R30 to R77</b> - right angle bends (pg 9) <b>SO</b> - stand off insulators (pg 9) <b>S1</b> - solder lug/flat  <b>Covers</b> - (pg 23)

†Contact factory for configuration..

### Terminal Styles

Inches (Millimeters)



**01**  
Handwired



**02**  
Printed Circuit



**03**  
Non Feed-Thru



**04**  
Wire Wrap Tail



**05**  
Extended Handwired



**06**  
Handwired



**07**  
Extended Pin



**08**  
Printed Circuit

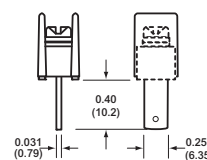

**09**  
0.250" QC short

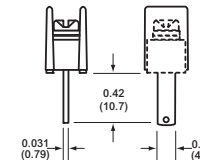

**10**  
0.187" QC

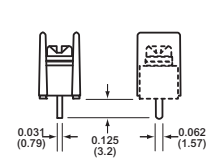

**14**  
Printed Circuit

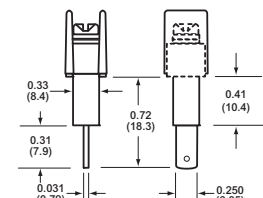

**19**  
√0.250" QC long

# Terminal Blocks - Single Row

## Series A2000 & LP2000 Single Row Terminal Blocks *Continued*

### Screw Options



### Hardware Options (Bulk ordering part numbers are in parentheses.)

Inches (Millimeters)

#### Solder Lugs



#### Jumpers



#### Quick Connects

Blade Width A = 0.250" Blade Width B = 0.187"



†Contact factory for configuration.

### Base/End Options

Inches (Millimeters)

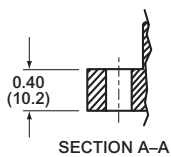

0, 6 & 9  
Molded Mount End

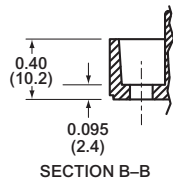
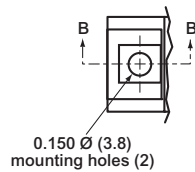

1, 3 & 5  
Mount End

## Series A2000 & LP2000 Single Row Terminal Blocks *Continued*

### Mounting Options

#### Right Angle Bends (A2, LP2 only)

Right angle terminals are offered on the A2000 & LP2000 Series. Configurations are defined in these dimensions: X = pin extension beyond the block base; Z = length from block base to centerline of the terminal tip. Standard bends consist of the X and Z dimensions shown in the chart. Specify by adding the selected Bend Option Code to the terminal part number.

#### 04 Terminal Bend Configurations



Bend Option Code	X (minimum)	Z	Available w/insulator base
R30	0.04	0.28	No
R35	0.01	0.23	No
R36	0.02	0.22	No
R39	0.05	0.19	No
R42	0.08	0.16	No
R46	0.12	0.12	No
R48	0.14	0.10	No
R50	0.16	0.08	No

#### 07 Terminal Bend Configurations



Bend Option Code	X (minimum)	Z	Available w/insulator base
R30	0.04	0.55	Yes
R35	0.01	0.50	Yes
R36	0.02	0.49	Yes
R42	0.08	0.43	Yes
R46	0.12	0.39	Yes
R50	0.16	0.35	No
R53	0.19	0.32	No
R66	0.32	0.19	No
R69	0.35	0.16	No
R75	0.41	0.10	No
R77	0.43	0.08	No

Dimensions in inches. To convert to millimeters, multiply by 25.4.

#### Angle Brackets (A2, LP2 only)

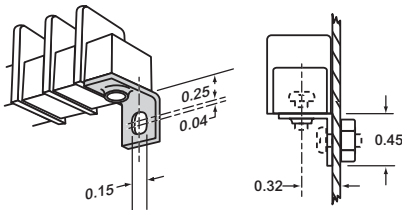

#### Option AB

Angle brackets enable block to be fastened at right angles to normal mount position. Bulk part number **2AB-J**.

#### Drilled Right Angle (A2, LP2 only)

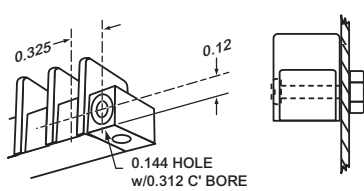

#### Option DR

Counterbored holes across mount ends of block enable fastening with two screws at right angles to normal mount position.

#### Mounting Plates



#### Options MP, MP8 & MT

**MP** Metal inserts with 0.150" dia. hole accept #6 screw. **MP8** Metal inserts with 0.187" dia. hole accept #8-32 screw. **MT** Metal inserts with tapped hole accept #6-32 screw.

#### Standoffs

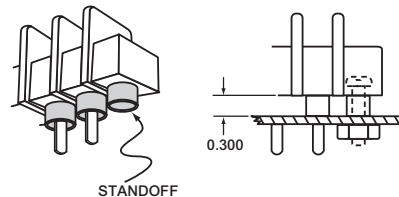

#### Option SO

Standoff mounts are tubes molded to the mounting positions. Available with insulator bases only.

#### Retaining Clip



#### Option RC

Use on standoff tubes. Fit panels up to 0.125" thick. Two clips for every five positions. Supplied unassembled. Bulk part number **H541-J**.

# Terminal Blocks - Single Row

## Series CB2000

### Single Row Terminal Blocks

#### Part Numbering System

Series	Terminal Style	Base/End	Poles	Screws	Options
<b>CB2</b>					
CB2 - closed back	<b>01</b> - handwired <b>02</b> - printed circuit <b>03</b> - non feed-thru <b>07</b> - extended pin <b>14</b> - printed circuit <b>22</b> - dual tail printed circuit	<b>1</b> - mount end <b>2</b> - barrier end	<b>02 to 32</b> 02 to 30 on mount end base	<b>03</b> - stainless steel <b>04</b> - brass nickel-plated <b>07</b> - steel SEMS standard <b>09</b> - brass SEMS nickel-plated <b>CA</b> - captive screw <b>07CA</b> - SEMS captive	<b>*AB</b> - angle mounting brackets (pg 11) <b>A7 to A9</b> - 0.250" QC <b>B7 to B9</b> - 0.187" QC <b>EB</b> - exit back terminals <b>EF</b> - exit front terminals † <b>JA, JB &amp; JC</b> - barrier jumpers <b>L1 to L6</b> marking options (pg 22) <b>LT1 to LT6</b> marking options (pg 22) † <b>OJ2 &amp; OJ4</b> - over barrier jumpers <b>MP, MP8, MT &amp; MT8</b> mtg. plates (pg 11) <b>S1</b> - solder lug/flat

\*Only available on 3-poles and up.  
 †Contact factory for configuration.

#### Terminal Styles

Inches (Millimeters)

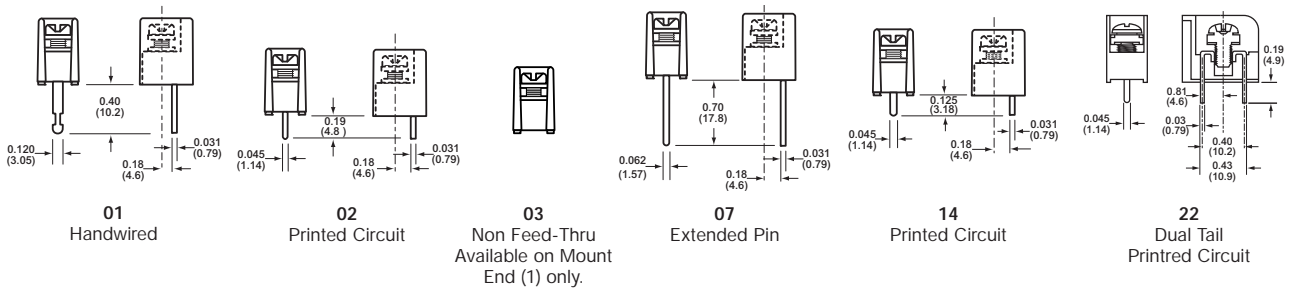

#### Screw Options (Bulk ordering part numbers are in parentheses.)

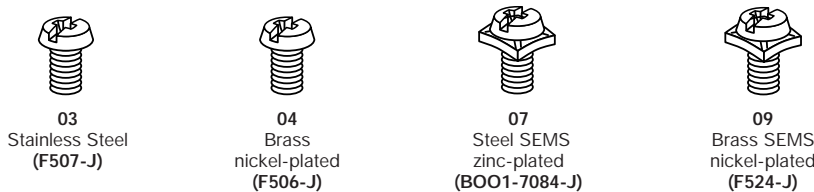

\* NOTE: Wire ready screws standard on all terminal styles.

#### CB2 Terminal Exit Options

Inches (Millimeters)

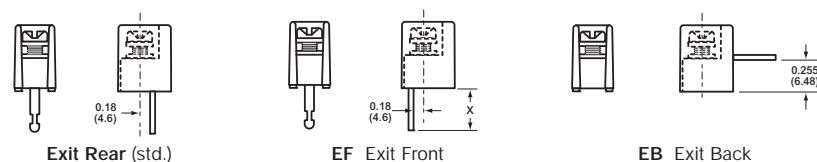

## Series CB2000 Single Row Terminal Blocks

### Hardware Options (Bulk ordering part numbers are in parentheses.) Inches (Millimeters)

#### Solder Lugs

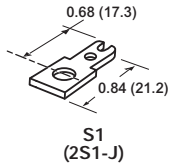

#### Jumpers

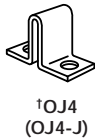
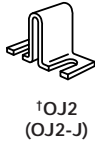
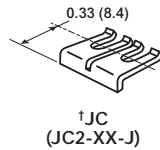
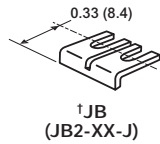
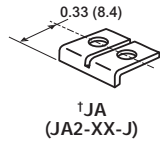

#### Quick Connects

Blade Width A = 0.250". Blade Width B = 0.187".

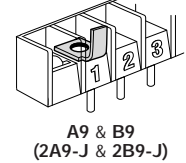
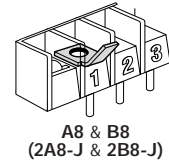
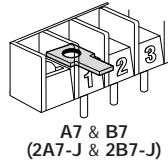

†Contact factory for configuration.

### Mounting Options Inches (Millimeters)

#### Right Angle Mounting Bracket

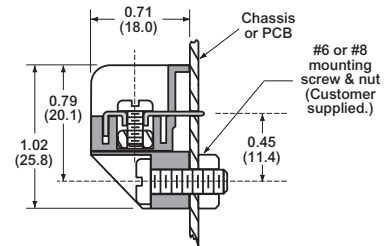
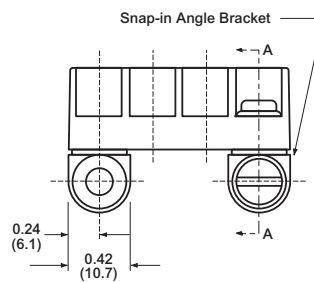
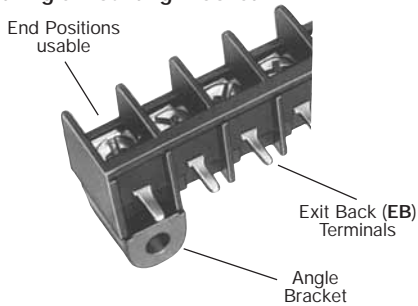

#### Option AB

#### Mounts blocks on PC boards at a right angle.

- Protects solder joints.
- Recommended for all EB (Exit Back) PCB terminal blocks.
- Bracket snaps securely on block (no hardware required).
- Minimum strip length (end positions are usable).
- Mount with #6-32 or #8-32 screws (not supplied).

#### Mounting Plates

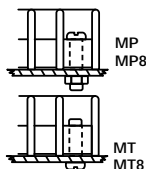
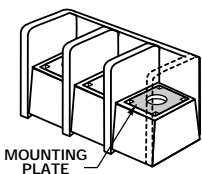

#### Options MP, MP8, MT & MT8

- MP Metal inserts with 0.150" dia. hole accept #6 screw.
- MP8 Metal inserts with 0.187" dia. hole accept #8-32 screw.
- MT Metal inserts with tapped hole accept #6-32 screw.
- MT8 Metal inserts with tapped hole accept #8-32 screw.